

DIN 3402

Прес-масльонка

A 180°

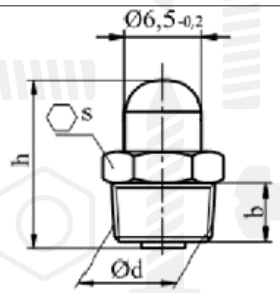

B 45°

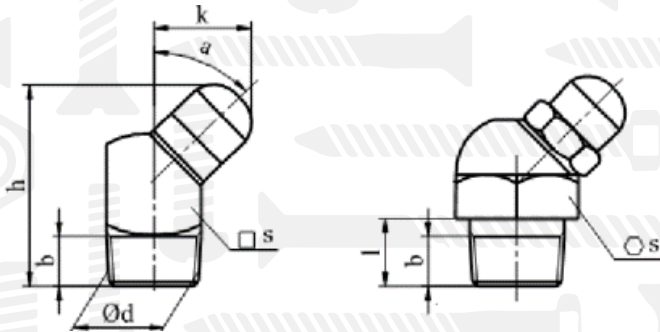

C 90°

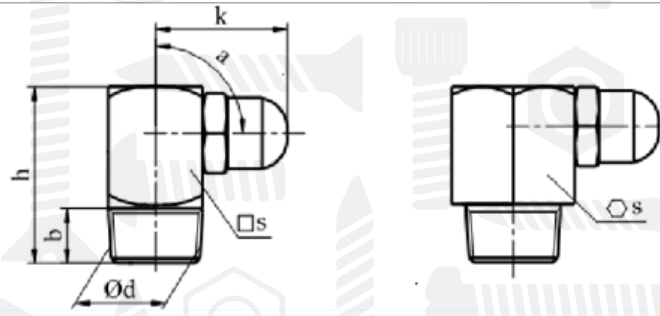

Розмір/Діаметр

| Форма | d ¹⁾ | h | b | s | Номер | | |
|-------|-----------------|----|-----|---|-----------------|-------------------------|---------|
| | | | | | Сталь, оц. Біла | Сталь нерж. А1 (1.4305) | Латунь |
| A | M5x0,8 | 14 | 5,5 | 7 | 2100701 | - | 2110702 |
| | M6x075 | 14 | 5,5 | 7 | 2100703 | - | 2110703 |
| | M6x1 | 14 | 5,5 | 7 | 2100704 | - | 2110704 |
| | M7x1 | 14 | 5,5 | 9 | 2100905 | - | - |
| | M8x1 | 14 | 5,5 | 9 | 2100907 | 2120907 | 2110907 |
| | M8x1,25 | 14 | 5,5 | 9 | 2100908 | - | - |

























d - діаметр
b - довжина різьби
h - висота

k - довжина шуцера
s - розмір під ключ

DIN 3402

Прес-масльонка

Розмір/Діаметр

| Форма | d ¹⁾ | h | b | l | k | s | α | Номер | | |
|----------------|-----------------|------|-----|------|-----|--|---|-------------------|----------|----------|
| | | | | | | | | Сталь.оц. Біла | Латунь | |
| A | M10x1 | 14 | 5,5 | - | - | 11 |  | - | 2101109 | - |
| | M10x1,5 | 14 | 5,5 | - | - | 11 |  | - | 2101111 | - |
| | R1/8, 1/8-28BSP | 14 | 5,5 | - | - | 11 |  | - | 2101156 | 2111156 |
| | R1/4, 1/4-19BSP | 16 | 6,5 | - | - | 14 |  | - | 2101457 | 2111457 |
| | R3/8, 3/8-19BSP | 17,5 | 8 | - | - | 17 |  | - | 2101758 | - |
| B | M6x1 | 19 | 5,5 | - | 9 | 9 |  | 45° | 2204504 | - |
| | M8x1 | 19 | 5,5 | - | 9 | 9 |  | 45° | 2204507 | - |
| | M8x1,25 | 19 | 5,5 | - | 9 | 9 |  | 45° | 2204508 | - |
| | | 19 | 5,5 | - | 9 | 11 |  | 45° | - | 2111458 |
| | | 20 | 5,5 | 6 | 9,5 | 11 |  | 45° | - | 2111470 |
| | M10x1 | 14 | 5,5 | - | 9,5 | 11 |  | 45° | 2204709 | - |
| | M10x1,5 | 20 | 5,5 | 6 | 9,5 | 11 |  | 45° | - | 2111471 |
| | | 27 | 5,5 | 9,5 | 9,5 | 11 |  | 45° | 2204711 | - |
| | R1/8, 1/8-28BSP | 14 | 5,5 | - | 9,5 | 11 |  | 45° | 2204756 | - |
| | | 14 | 5,5 | - | 9,5 | 11 |  | 45° | - | 2111460 |
| R1/4 1/4-19BSP | 22 | 6,5 | - | 11,5 | 14 |  | 45° | 2201457 | - | |
| C | M6x1 | 18 | 5,5 | - | 13 | 9 |  | 90° | 2304504 | - |
| | M8x1 | 18 | 5,5 | - | 13 | 9 |  | 90° | 2304507 | - |
| | M8x1,25 | 18 | 5,5 | - | 13 | 9 |  | 90° | 2304508 | - |
| | | 18 | 5,5 | - | 13 | 9 |  | 90° | 2111461* | - |
| | | 19 | 5,5 | - | 13 | 11 |  | 90° | 2111468* | - |
| | M10x1 | 18 | 5,5 | - | 14 | 11 |  | 90° | 2304709 | - |
| | M10x1,5 | 19 | 5,5 | - | 13 | 11 |  | 90° | - | 2111469* |
| | R1/8, 1/8-28BSP | 18 | 5,5 | - | 14 | 11 |  | 90° | 2304756 | - |
| R1/4 1/4-19BSP | 22,5 | 6,5 | - | 15 | 14 |  | 90° | 2301457 | - | |

d - діаметр
 b - довжина різьби
 h - висота
 k - довжина штуцера
 s - розмір під ключ