

DIN 3405

Прес-масльонка

Форма

Малюнок

45°

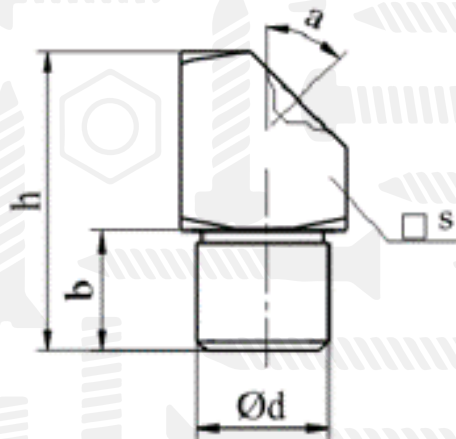



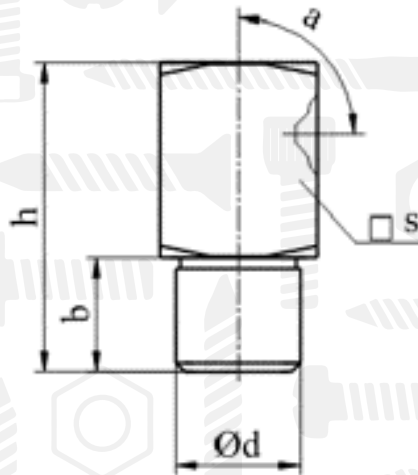



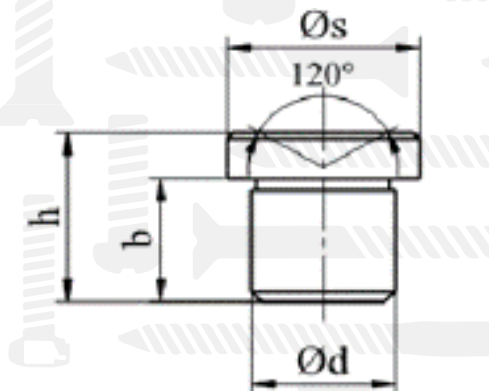



90°



100°



Розмір/Діаметр

Форма	d	h	b	s	α	Номер			
						Сталь оц.Біла	Сталь нерж. А1 (1.4305)	Латунь	
A	Ø 5	7,5	5,5	8		180°	3100185	-	-
	Ø 6	7,5	5,5	8		180°	3100186	3120186	3110186
	Ø 8	9,5	6,5	10		180°	3100288	3120288	3110288
	Ø 10	9,5	6,5	12		180°	3,1E+07	-	3110389
	Ø 1/4"	7,5	5,5	8		180°	3100187	-	-
B	Ø 6	15	5,5	9		45°	3204586	-	-
	Ø 8	15	5,5	9		45°	3204588	-	-
	Ø 10	15	5,5	11		45°	3204789	-	-
C	Ø 6	18	5,5	9		90°	3304586	-	-
	Ø 8	18	5,5	9		90°	3304588	-	-
	Ø 10	18	5,5	11		90°	3304789	-	-

d - діаметр
b - довжина різьби
h - висота