

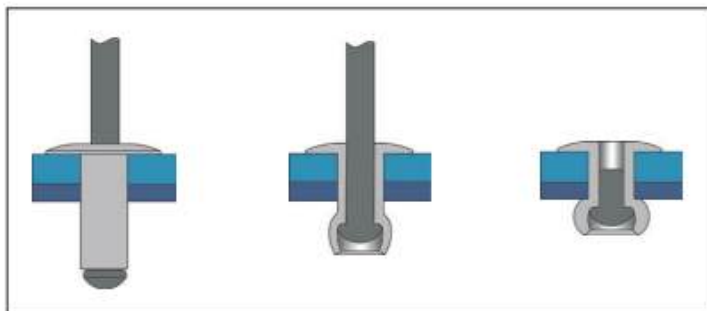

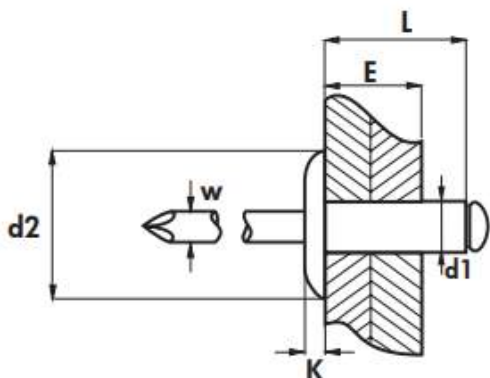



ISO 15977 Заклепка витяжна з плоским збільшеним буртиком Bralo



Розмір/Діаметр

d1	4,0							4,0		4,8
L	8	10	12	14	16	18	20	18	25	21
E	3,0-5,0	5,0-6,5	6,5-8,5	8,5-10,5	10,5-12,5	12,5-14,5	14,5-16,5	8,0-12,0	12,0-18,0	14,0-17,0
	4,10							4,10		4,90
d2	12,00							15,00		11,00
K	1,40							1,60		1,60
W	2,20							2,20		2,65
 (N)	1250							1800		1850
 (N)	1800							3800		2600

Розмір/Діаметр



d1	4,8									
L	10	12	14	16	18	21	24	27	30	35
E	4,5-6,0	6,0-8,0	8,0-10,0	10,0-12,0	12,0-14,0	14,0-17,0	17,0-20,0	20,0-23,0	23,0-25,0	25,0-30,0
	4,90									
d2	14,00									
K	1,80									
W	2,65									
 (N)	1850									
 (N)	2600									

d1- діаметр
L - довжина
E - діапазон товщини
d2 - діаметр буртика
K - ширина буртика
W - діаметр цвяшка

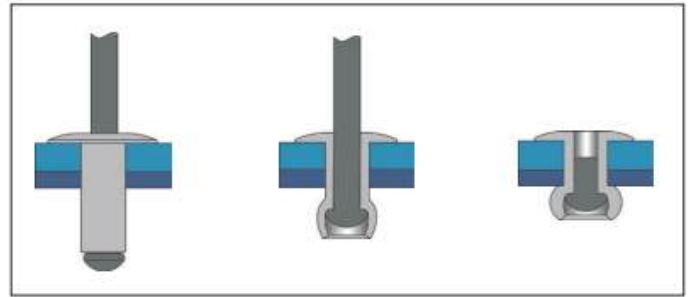
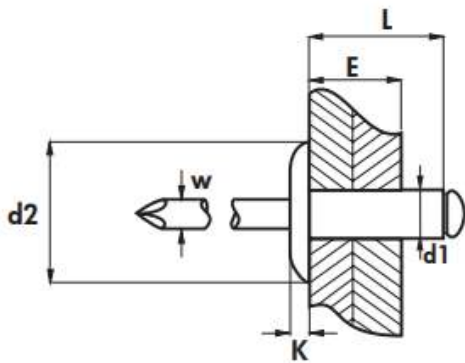

ISO 15977 Заклепка витяжна з плоским збільшеним буртиком Bralo



Розмір/Діаметр

d1	4,8									
L	10	12	14	16	18	21	24	27	30	35
E	3,5-6,0	6,0-8,0	8,0-10,0	10,0-12,0	12,0-14,0	14,0-17,0	17,0-20,0	20,0-23,0	23,0-25,0	25,0-30,0
	4,90									
d2	16,00									
K	1,80									
W	2,65									
 (N)	1850									
 (N)	2600									

Розмір/Діаметр



d1	5,0							
L	10	12	14	16	18	20	25	30
E	4,5-6,0	6,0-8,0	8,0-10,0	10,0-12,0	12,0-14,0	14,0-16,0	16,0-21,0	21,0-25,0
	5,10							
d2	11,00							
K	1,60							
W	2,65							
 (N)	2150							
 (N)	3100							

d1- діаметр
L - довжина
E - діапазон товщини
d2 - діаметр буртика
K - ширина буртика
W - діаметр цвяшка

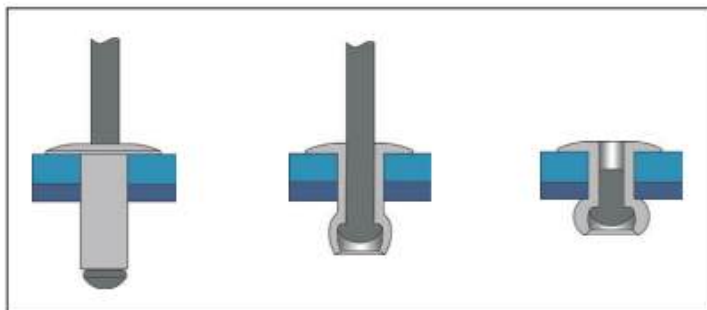
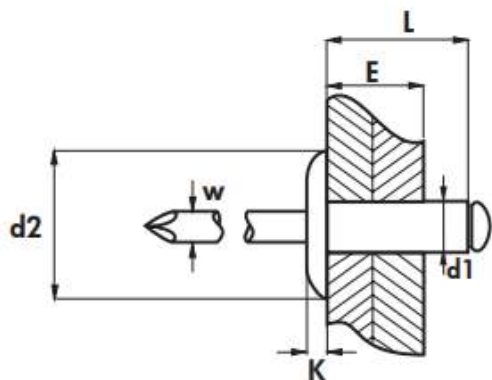
ISO 15977 Заклепка витяжна з плоским збільшеним буртиком Bralo



Розмір/Діаметр

d1	5,0								
L	8	10	12	14	16	18	21	24	30
E	3,0-4,5	4,5-6,0	6,0-8,0	8,0-10,0	10,0-12,0	12,0-14,0	14,0-16,0	16,0-21,0	21,0-25,0
	5,10								
d2	14,00								
K	1,80								
W	2,65								
 (N)	2150								
 (N)	3100								

d1- діаметр

L - довжина

E - діапазон товщини

d2 - діаметр буртика

K - ширина буртика

W - діаметр цвяшка